

B to B 可動コネクタ

A18-QAY-0006 rev.1

Board to Board Connector

取り扱い説明書

Manual

適用製品：B to B 可動コネクタ

Application product : Board to Board Connector

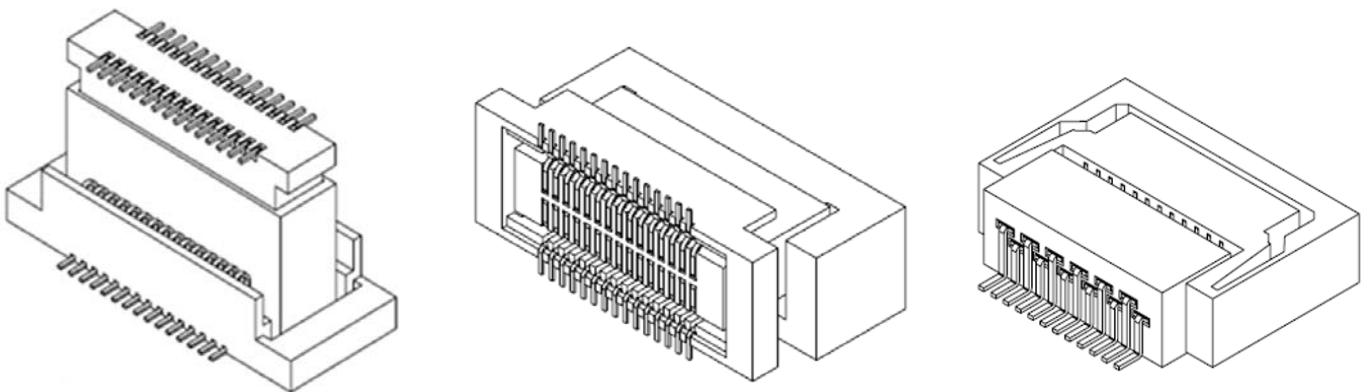

《取り扱い方法》 Handling method

1. 可動量 / Floating range

・ 本仕様書の適用プラグ/ソケットの嵌合において、下記の可動量を保証する。 /

To guarantee the floating range of the following.

・ 下記のモデル形状は参考とします。(現物と異なる場合があります) /

The following model shapes are for reference.

(It differs from a actual connector.)

各方向の可動量、使用範囲はシリーズ毎の仕様書をご確認ください。

Refer to the specifications for each series

for the movable amount in each direction and the usage range.

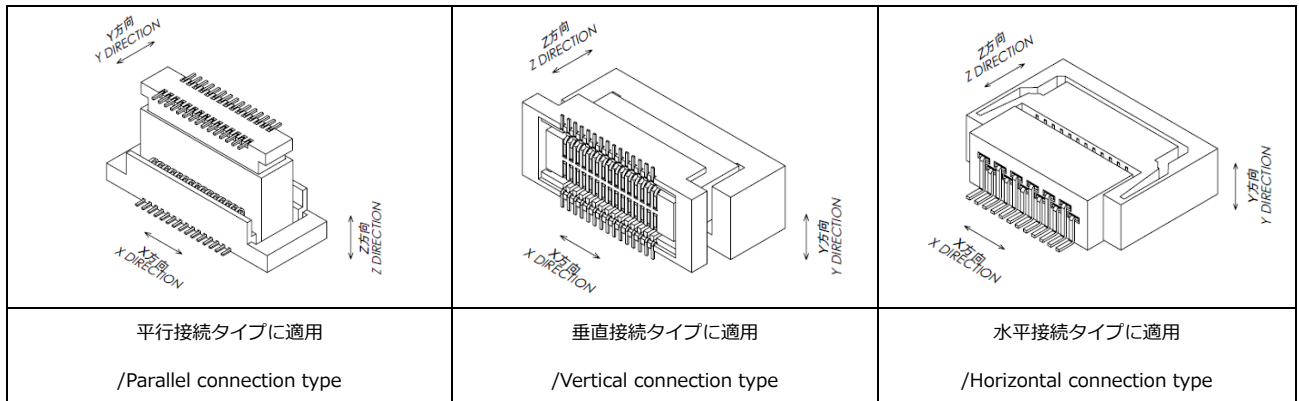

2. 使用上の注意 / Attention of using connector

・ 斜め嵌合やこじり等の無い様にゆっくりと挿抜して下さい。

/When the connector is mating, shall not be twisted, and then mated it slowly.

・ 角度を付けた状態で押し込むとモールド端面どうしが強く擦れる事により、削りカスが発生します。

/The angled mating, occurs shavings.

・ 位置決め後、モールド両端がゆるく嵌まった事を確認して真っ直ぐ押し込んで下さい。

/After positioning, please check that mold both ends have fitted in loosely, and push in straight.

・ 抜去時は真っ直ぐ抜いて下さい。コネクタの片側だけが持ち上がる様な回転抜去を行いますと

モールドが破損する可能性があります。

/Please be pulled out straight. Pulling on one side, the mold is broken.

・ 下記のモデル形状は参考とします。(現物と異なる場合があります)

/It refers to the model shape of the reference of the following.

(It differs from a actual connector.)

・ コネクタのみで基板の固定は行なわないで下さい。使用の際、コネクタの実装位置に近い位置で、

必ず基板をビスにて確実に固定して下さい。コネクタに掛かる加速度は、セット組立品に於いても 43.12m/s²以下とする事。(共振振動が加わらない事。)

/It shall not be held the connector only, when you are assembled for the connector and P.C.B.

When it shall be used the connector, the P.C.B. are held by the rivet certainty near mounting of the connector.

Acceleration of connector : 43.12m/s² or less. (The connector shall not be added to be added to resonance acceleration.)

・位置をガイドする治具を用いての嵌合を推奨いたします。嵌合位置がずれた状態で押し込むと、破損、変形の可能性があります。

位置決め後、モールド両端がゆるく嵌まった事を確認して真っ直ぐ押し込んで下さい。

/ It is recommended to engage with a jig that guides the position.

If it is pushed in a state where the mating position is displaced, there is a possibility of damage or deformation.

After positioning, please check that mold both ends have fitted in loosely, and push in straight.

(例 / Example)

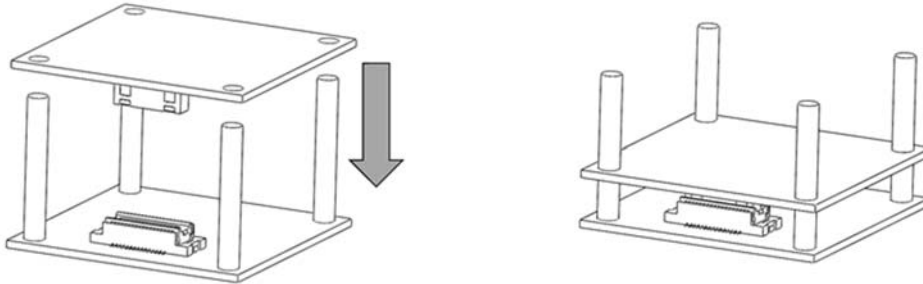

・誘い込み時の角度は図1～図2になりますので、記載角度以下で位置決めして下さい。

Figure 1 and 2 show guiding angle. Please locate it below the described angle.

(誘い込み時の角度とは最初の位置決め角度であり、嵌合可能な角度ではありません。)

(Guiding angle is initial location angle. It is not the angle to mate.)



図 1/ Fig.1(平行接続タイプ/Parallel connection type)

誘い込み時の角度
Guiding angle



図 2/ Fig.2(平行接続タイプ/ Parallel connection type)

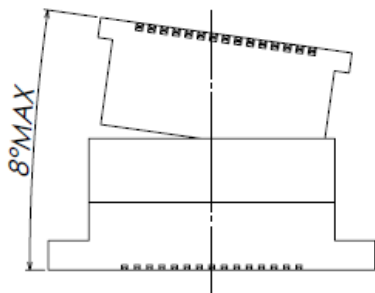

図 1/ Fig.1(垂直接続タイプ/Vertical connection type)

誘い込み時の角度
Guiding angle

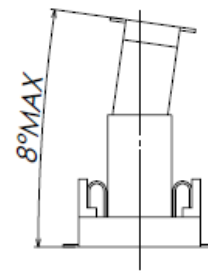

図 2/ Fig.2(垂直接続タイプ/ Vertical connection type)

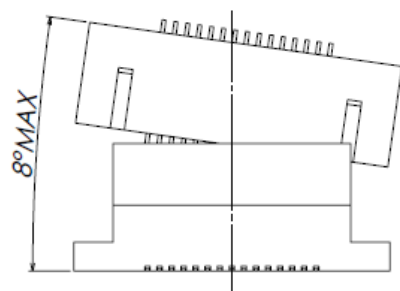

図 1/ Fig.1(水平接続タイプ/Horizontal connection type)

誘い込み時の角度
Guiding angle

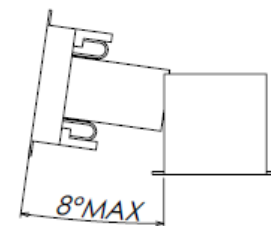

図 2/ Fig.2(水平接続タイプ/Horizontal connection type)

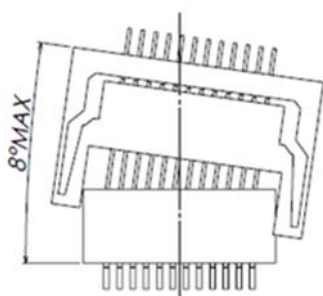
・ 嵌合時の許容角度は図 3～図 4 になりますので、記載角度以下で使用して下さい。

Please mate below the angle of the figure 3,4.

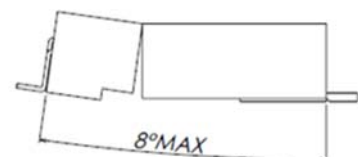
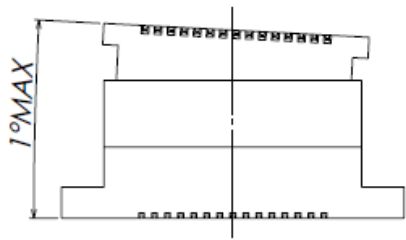

嵌合角度
Mating angle



図 3/ Fig.3(平行接続タイプ/Parallel connection type)

図 3/ Fig.3(平行接続タイプ/ Parallel connection type)



嵌合角度
Mating angle

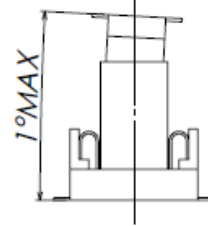
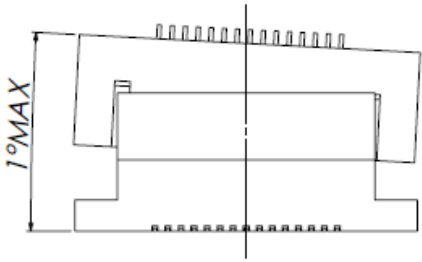

図 3/ Fig.3(垂直接続タイプ/Vertical connection type)

図 4/ Fig.4(垂直接続タイプ/ Vertical connection type)



嵌合角度
Mating angle

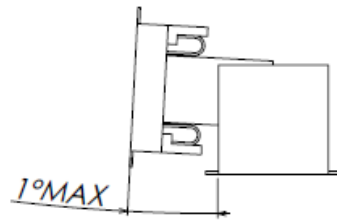
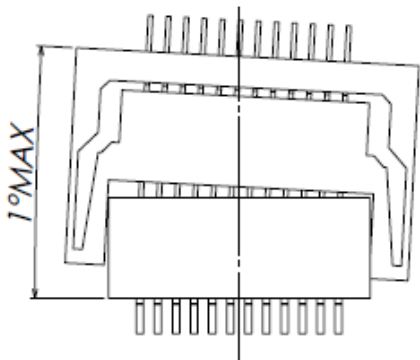

図 3/ Fig.3(水平接続タイプ/Horizontal connection type)

図 4/ Fig.4(水平接続タイプ/Horizontal connection type)

・ 嵌合後のコネクタが可動域を超えて変位するような外力やこじりが発生しないようにしてください。破損、変形が起こる可能性があります。

Please do not make the external force and twisting to move beyond the range of motion after you fit the connector.

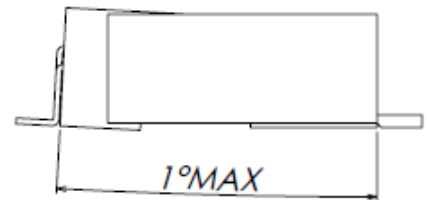
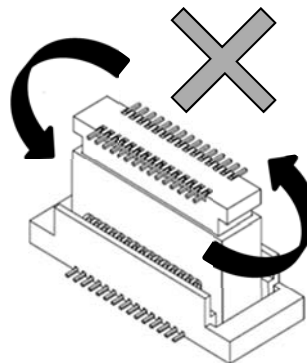
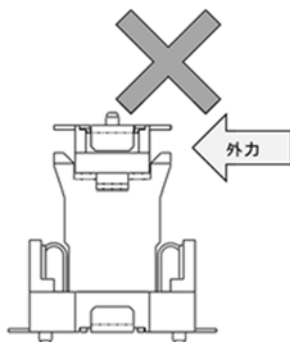

× : 禁止行為 prohibited Operation

その他 Others

①コネクタ実装後、半田接合部が変色する場合がございますが
使用上問題ございません。

There is no problem in use though the solder joint part might discolor
after mounting the connector.

②モールド内に黒点が発生する場合がございますが、性能上
問題ございません。

There is no problem on the performance though the black spot might be
generated in molding.

③リフロー半田付け時、モールドに膨れが発生することが
ございますが、性能上問題ございません。

There is no problem on the performance though the swelling might be
generated in molding when the reflow solder is put up.

④異種金属嵌合は、行わないでください。

Please do not do the different kind metal mating.

⑤反転リフロー時に製品が落下する可能性がございますので
テープ等で補強することを推奨致します。

Since a product may fall at the time of reversal reflow,
I recommend reinforcing on a tape etc.

B to B 可动连接器

Board to Board Connector

A18-QAY-0006 rev.1

使用说明书

Manual

使用产品：B to B 可动连接器

Application product : Board to Board Connector

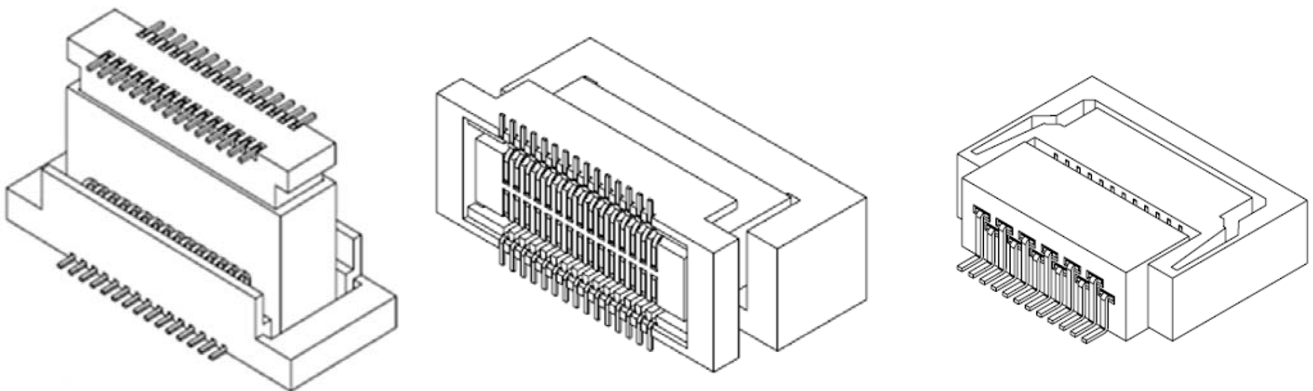

《使用方法》 Handling method

1. 可动量 /Floating range

· 我们保证，本式样书规定的公母连接器插接后的可动量

To guarantee the floating range of the following.

· 以下示意图仅作为参考。(可能会与实物有所不同)

The following model shapes are for reference. (It differs from a actual connector.)

各个方向的可动量及使用范围请参照各个系列的产品式样书规定

Refer to the specifications for each series for the movable amount in each direction and the usage range.

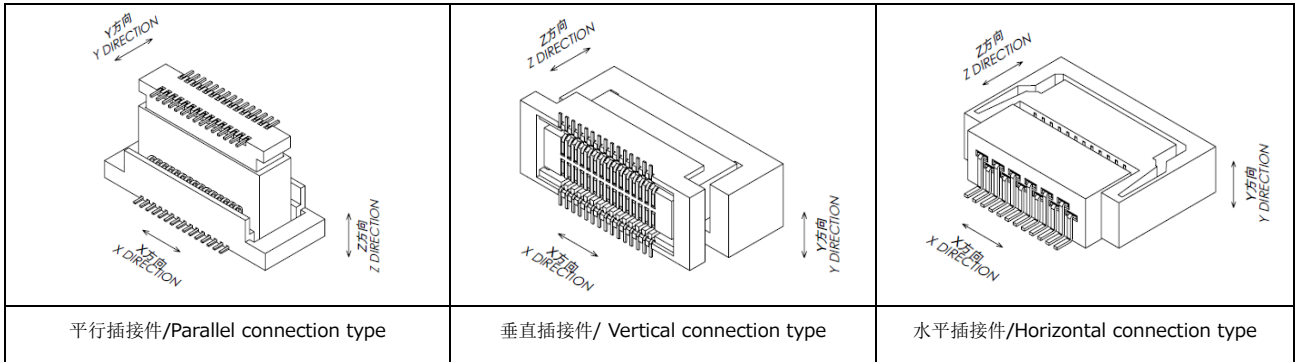

2. 使用时的注意事项/Attention of using connector

· 请缓慢插接，请勿斜着或扭上劲进行插接连接器。

/When the connector is mating, shall not be twisted, and then mated it slowly.

· 斜着插接，壳体之间产生摩擦，会产生摩擦粉

/The angled mating, occurs shavings.

· 找到对接位置，确认壳体接口之间是否到位后，缓慢进行插接

/After positioning, please check that mold both ends have fitted in loosely, and push in straight.

· 拔取时保持平行，请勿单边拔取连接器而产生回转，以免造成壳体的损坏。

/Please be pulled out straight. Pulling on one side, the mold is broken.

· 以下视图仅作为参考。(可能会与实物有所不同)

/It refers to the model shape of the reference of the following.

(It differs from a actual connector.)

· 请勿将连接器作为电路板之间的固定使用。必须在连接器实装位置的附近，用螺丝等确实有效的固定电路板。

对于组装件，连接器受到的加速度应小于 43.12 m / s^2 。(不能有共振现象)

/It shall not be held the connector only, when you are assembled for the connector and P.C.B.

When it shall be used the connector, the P.C.B. are held by the rivet certainty near mounting of the connector.

Acceleration of connector : 43.12m/s^2 or less. (The connector shall not be added to be added to resonance acceleration.)

· 建议使用定位导向装置。如果在切合位置不佳的状态下插接使用，会造成连接器的损坏或变形。找到对接位置，确认壳体切合口到位后，缓慢插接连接器。

/ It is recommended to engage with a jig that guides the position.

If it is pushed in a state where the mating position is displaced, there is a possibility of damage or deformation.

After positioning, please check that mold both ends have fitted in loosely, and push in straight.

(例 / Example)

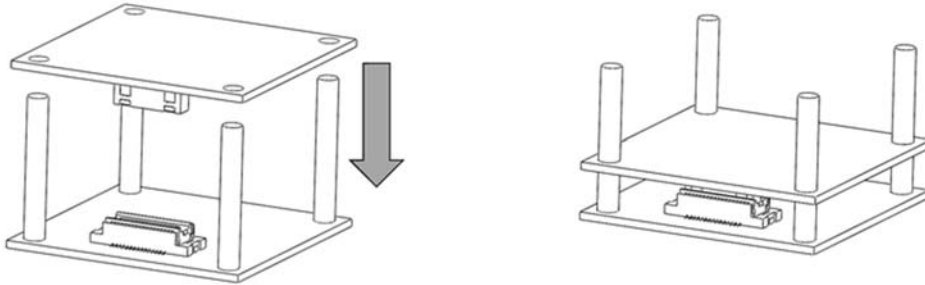

· 定位导向角度如图 1 至图 2 所示，请在图示角度以下进行插接连接器。

Figure 1 and 2 show guiding angle. Please locate it below the described angle.

(定位导向角度是最初定位角度，而不是可以插接连接器的角度。)

(Guiding angle is initial location angle. It is not the angle to mate.)



图 1/ Fig.1(平行对接型/Parallel connection type)

导向角度
Guiding angle



图 2/ Fig.2(平行对接型/ Parallel connection type)

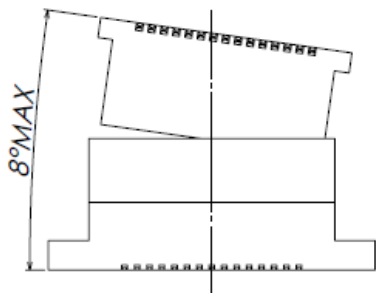

图 1/ Fig.1(垂直接型/Vertical connection type)

导向角度
Guiding angle

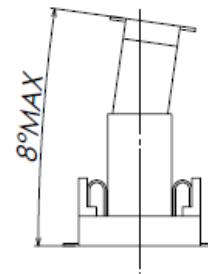

图 2/ Fig.2(垂直接型/ Vertical connection type)

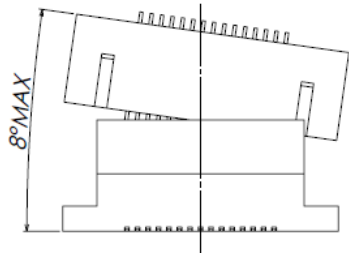

图 1/ Fig.1(水平对接型/Horizontal connection type)

导向角度
Guiding angle

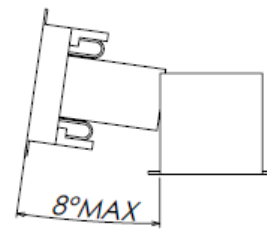

图 2/ Fig.2(水平对接型/Horizontal connection type)

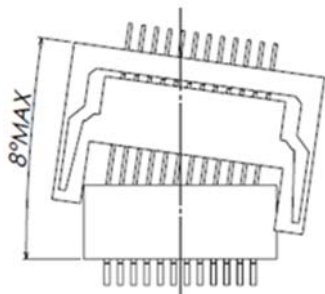
· 图 3 及图 4 表示对接时的最大角度，请在记载角度以下进行对接。

Please mate below the angle of the figure 3,4.

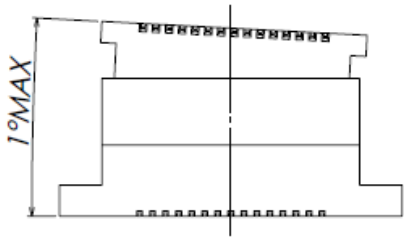

插接角度
Mating angle



图 3/Fig.3(平行对接型/Parallel connection type)

图 3/Fig.3(平行对接型/ Parallel connection type)



插接角度
Mating angle

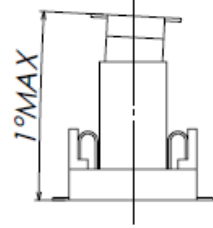
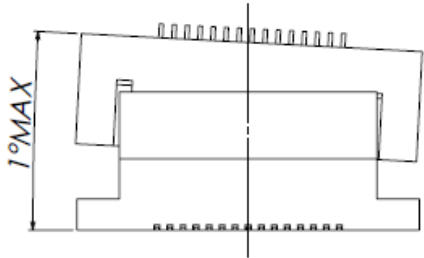

图 3/Fig.3(垂直对接型/Vertical connection type)

图 4/Fig.4(垂直对接型/ Vertical connection type)



插接角度
Mating angle

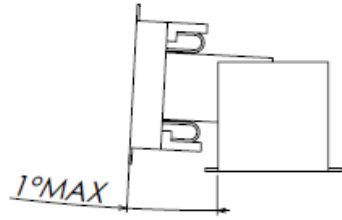
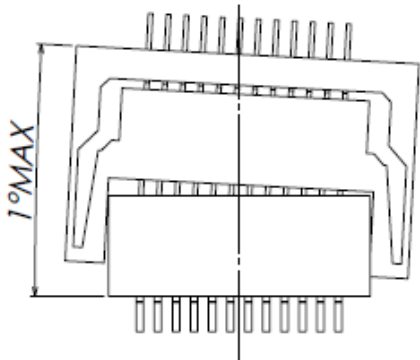

图 3/Fig.3(水平对接型/Horizontal connection type)

图 4/Fig.4(水平对接型/Horizontal connection type)

· 禁止超出连接器的使用可动量及扭上劲对接使用，以免造成连接器的损坏，变形。

Please do not make the external force and twisting to move beyond the range of motion after you fit the connector.

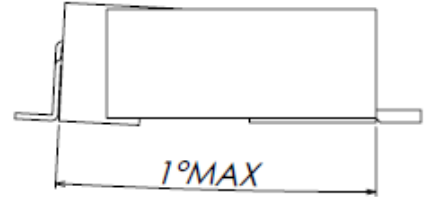
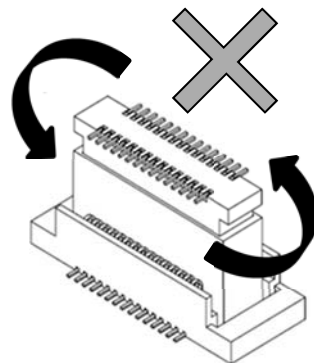
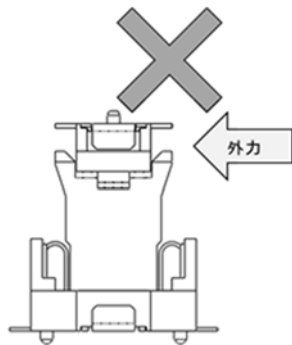

× : 禁止行为 prohibited Operation

补充 Others

① 实装后的连接器焊接部会有变色现象，但不会影响使用。

There is no problem in use though the solder joint part might discolor after mounting the connector.

② 体部会出现黑色斑点，但不会影响产品性能。

There is no problem on the performance though the black spot might be generated in molding.

③ 回流焊接后壳体上可能会出现气泡，但不会影响产品性能。

There is no problem on the performance though the swelling might be generated in molding when the reflow solder is put up.

④ 禁止不同电镀的产品进行对接使用。

Please do not do the different kind metal mating.

⑤ 2 次回流焊时，产品可能会脱落，请使用胶带等固定产品。

Since a product may fall at the time of reversal reflow, I recommend reinforcing on a tape etc.